

# System 1

## Fittings for Rigid Assembly Systems

### System Features

#### Double locking carcass screw

- Zinc diecast for precision
- Titus Double locking carcass screw makes an almost invisible connection
- Collar under the head to pull panels together
- 2nd 'lower' thread pulls against a 'faster' thread to provide maximum connection force and prevents overdriving of fastener
- Almost invisible in position
- Head can be 'fastcapped' or filled

#### Hi-Lo™ carcass construction screw

The Hi-Lo™ carcass construction screw (CCS) offers a strong, tolerant and cost effective connection with minimal panel preparation.

The combination effect of the elements of a Hi-Lo™ screw means

- A greater differential between drive torque and strip torque in fibrous and particle materials to ensure a reliable and repeatable fixing
- Hi-Lo™ threads provide minimum bursting forces
- 'Hi' thread gives low bursting component force from the sharp 30 degree angle thread
- 'Lo' thread at 60 degree angle uses the vertical force component to press fibrous and particle components of panels onto the 'Hi' thread and are contained by their greater height
- The very small shank on a Hi-Lo™ screw means less material displacement than conventional threads and enables minimum or partial drilling of pilot holes for quicker panel processing

#### Barrel nut (plastic)

- Used with Titus Hi-Lo™ screws
- Titus barrel nuts provide maximum strip torque for reasonable drive torque
- Capable of multiple reconnection repeatability

#### Cover caps

- Available in multiple colours
- All recess and head types offered
- High quality engineering polymers used in their construction
- Uniformity of holding with good tolerance
- Wide range of application and use conditions

# System 1

## Fittings for Rigid Assembly Systems

### Double Locking Carcase Screw

- High performance from widely spaced primary thread
- Finer secondary thread provides additional holding power and positive stop (no override)
- Increased support for vertical panel is gained from the funnel head with collar at its base
- One-piece fitting

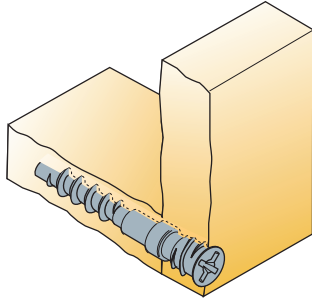

Technical and mounting details

Item number

Zinc

Screw 6x42

00180 →

885

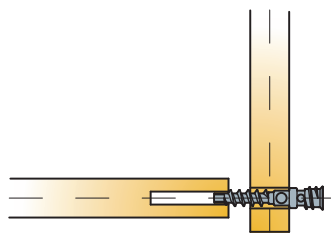
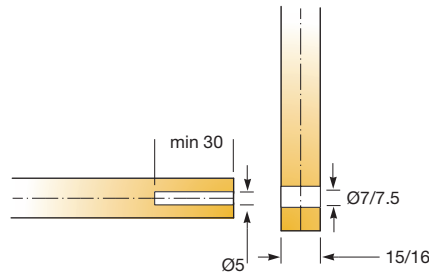
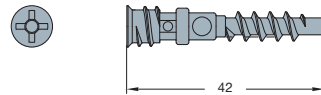

1. Insert screw to shoulder in face board

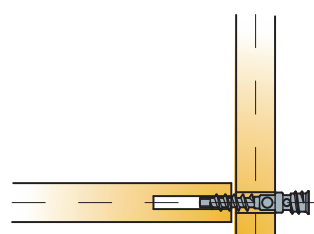

2. Screw into Ø5mm hole

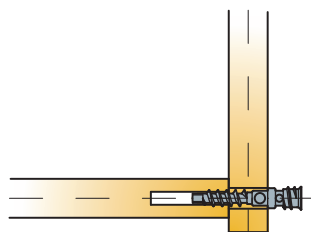

3. Board joint pulled up by collar on screw

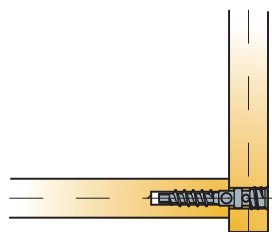

4. Board locked in place by screw



1000 Pcs

Made of zinc

# System 1 Fittings for Rigid Assembly Systems

## Hi-Lo™ Screw and Barrel Nut

- Hi-Lo™ screws have a twin thread for faster insertion
- 'Hi' threads and 'Lo' threads combine to give excellent pull out in chipboard
- Funnel head design means no countersinking
- Steel is case hardened for extra strength

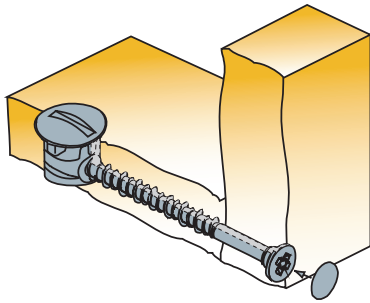

Technical and mounting details

### Hi-Lo™ screw

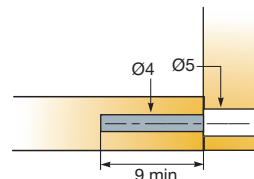
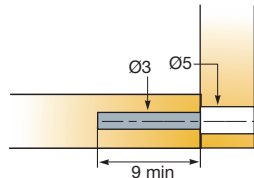
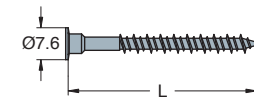

- 10000 Pcs (00062)
  - 9000 Pcs (00068)
  - 7000 Pcs (00071)
  - 4000 Pcs (00077, 00171, 06074)
  - 3000 Pcs (00172, 06077, 06080)
- Made of steel

Screw diameter	B	L	Drive type	Item number	Colour		
					Black	Phosphate	White
4		24		*00062 →	852		
4		28		*00068 →	852		
4		33		00071 →	852		
4	32	45		00177 →	852		
4	32	45		*00171 →	852		
4	32	55		00072 →	852		
4		38		06074 →	852		
4	32	50		*06077 →	852		
5	32	50		*06080 →	852		
<b>Drive type</b>				<i>*American market only</i>			
hexagonal drive		cross slot					

### Barrel nut

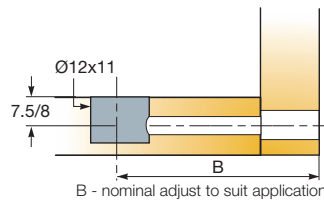

- 10000 Pcs
- Made of plastic

				01056 →	835		877
<i>Other colours on request</i>							

### Screw cap

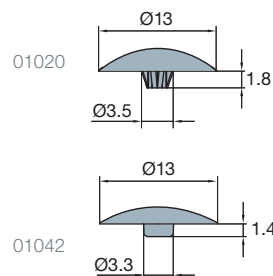





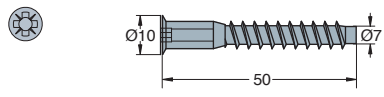
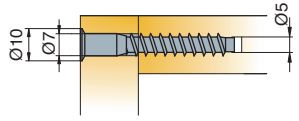

- 10000 Pcs (01042)
  - 5000 Pcs (01020)
- Made of plastic

pozi, philips drive				01020 →	835		877
hexagonal drive				01042 →	835		877
<i>Other colours on request</i>							

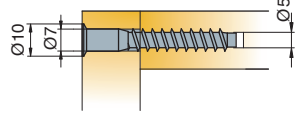
# System 1 Connecting Screws

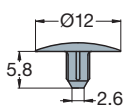
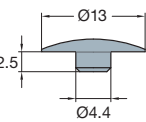
- Screws with crosshead PZ2 screwdriver or allen key slot
- Decorative cover caps are available in different colours

Technical and mounting details		Item number	Zinc plated	Ochre	White
<p><b>Crosshead screwdriver slot</b></p>   		827-6202 →	040		
 1000 Pcs	Made of steel				
<p><b>Allen-key slot</b></p>   		827-6201 →	040		
 1000 Pcs	Made of steel				
<p><b>Cover caps for connecting screws</b></p> 	<p>Universal</p> <p>For allen key slot head</p>  <p>827-4013</p>  <p>827-4130</p>	<p>827-4013 →</p> <p>827-4130 →</p>		330	350
 1000 Pcs (827-4130)  2000 Pcs (827-4013)	Made of plastic				