

NEW

Superior Strength
for Greater
'Confidence in Use'

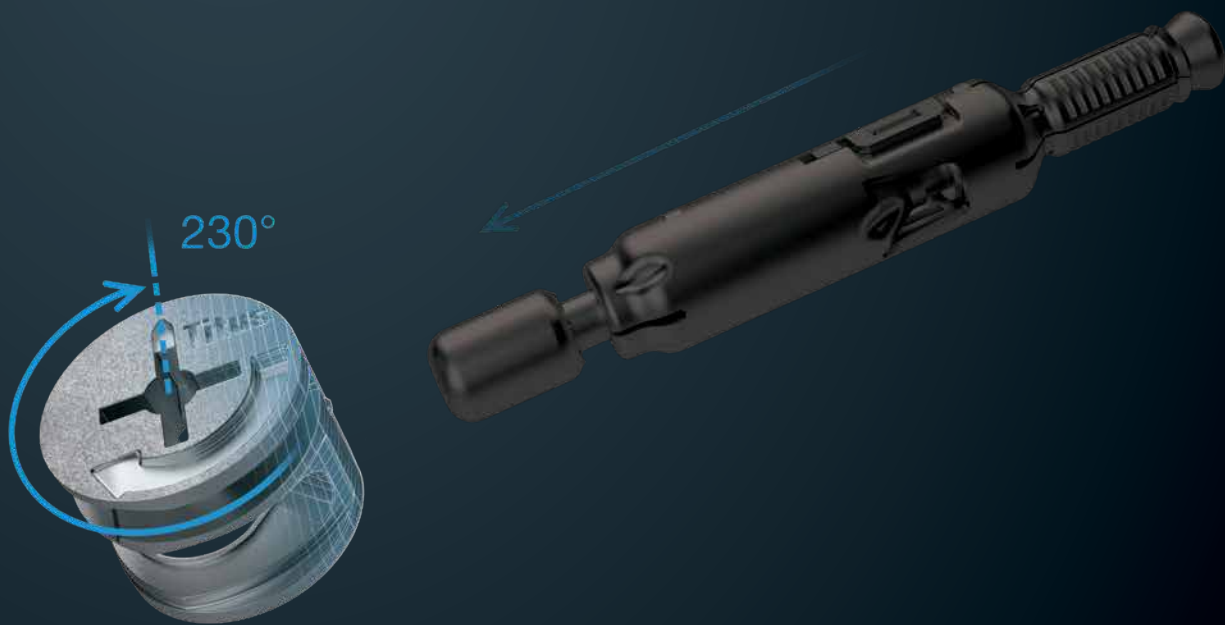

Titus New Generation Cam5000

- Highly resistant joint
- Great dowel pull-up
- Effective performance
in a wider tolerance range
- Smooth tightening action

Cam5000

Superior Strength for Greater 'Confidence in Use'

Highly resistant joint for stronger cabinet construction

Reinforced cam evenly engages the hole and prevents cam tilting.



Balanced force distribution prevents cam bursting while tightening.

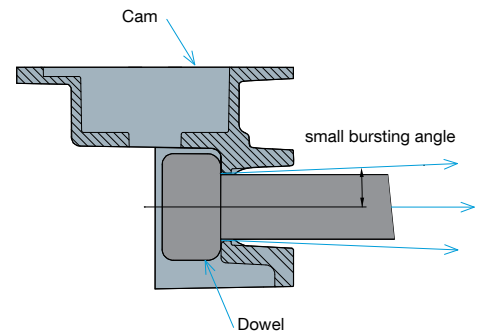

Increased joint resistance enables effective performance in wider tolerance range.

The cabinet construction remains strong even with multiple assemblies.

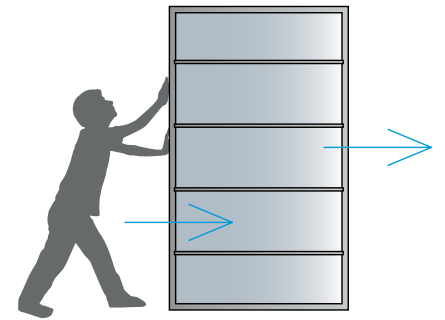

Reliable and comfortable locking

Improved linear cam profile ensures smooth tightening action and greater dowel pull-up



Smooth and noticeable locking at 2 o'clock guarantees:

- tight joints
- always-right tightening at home assembly
- strong and rigid cabinet construction

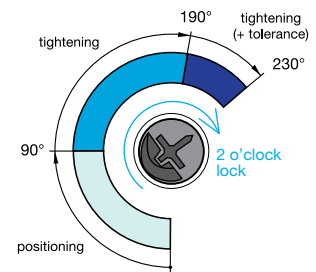

Highly resistant joint with no gaps between panels

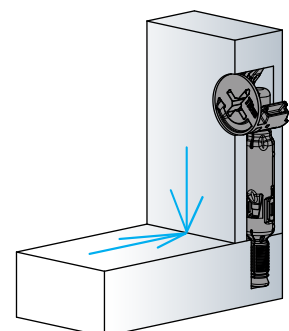

Optimal performance with all Titus dowels

Quickfit TL, Quickfit, Combi, end, double ended, angled and other screw-in dowels



Cam5000 retains all the standard features of Titus cam family

A wealth of experience from four decades of designing and providing cam & dowel solutions

Cam retaining pips ensure the cam is held in panel position prior to assembly

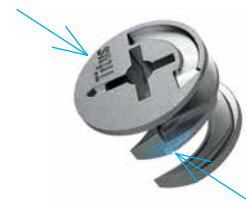

Titus 'Klix' locking system ensures the engagement of the interlocking teeth providing vibration proof joint and rigid construction that will not loosen in transit or service.



Technical and mounting details

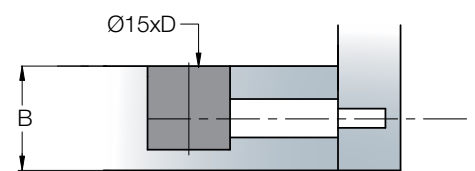

Drilling	15mm
Panel thickness B	12/13mm, 15/16mm, 18/19mm
Drilling depth D	10.5mm, 12.5mm, 14mm
Drive type	PZ2, PZ2 + HEX
Application	manual insertion, factory insertion
Dowels	Quickfit TL, Quickfit, Combi, end, double ended, angled and other screw-in dowel

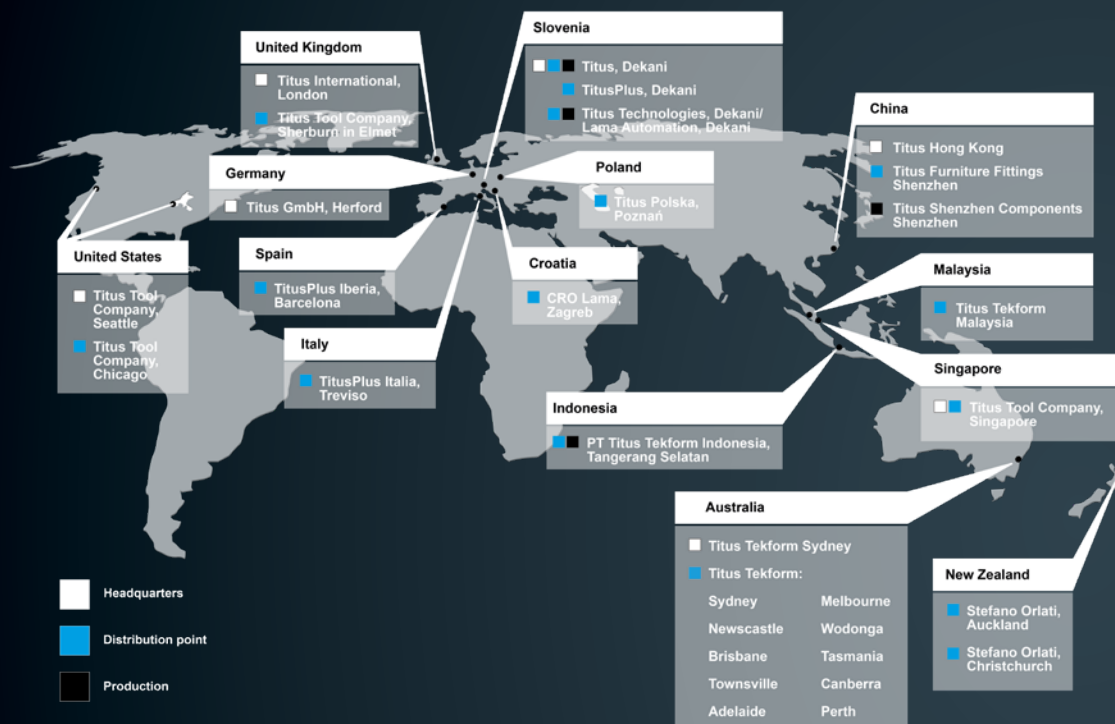

Europe

Titus d.o.o. Dekani

Dekani 5
 SI-6271 Dekani
 Slovenia
 +386 5 6690 213
 +386 5 6690 205 Fax
 info@titusplus.com

Titus Technologies d.o.o.

Dekani 5
 SI-6271 Dekani
 Slovenia
 +386 5 6690 000
 technologies@titusplus.com

Titus Tool Company Ltd.

10 Blackburn Industrial Estate
 Enterprise Way
 Sherburn in Elmet
 LS256NA
 United Kingdom
 +44 1977 682582
 +44 1977 680481 Fax
 uk@titusplus.com

CRO LAMA d.o.o.

Rakitska 10a
 Rakitje
 HR-10437 Bestovje
 Croatia
 +385 1 3323 033
 +385 1 3323 233 Fax
 croatia@titusplus.com

Titus Polska Sp. z o.o.

ul. Stefańskiego 17 A
 PL-62-002 Suchy Las/Poznań
 Poland
 +48 61 811 5402 Phone/Fax
 +48 61 811 5684 Phone/Fax
 +48 61 821 9362
 poland@titusplus.com

TitusPlus Italia S.r.l.

Via Aquileia 9
 Frazione Olmi
 IT-31048 San Biagio di Callalta (TV)
 Italy
 +39 04 221 650 120
 +39 04 221 650 136 Fax
 italia@titusplus.com

TitusPlus Iberia S.L.U.

C/ Luxemburg 16
 ES-08520 Les Franqueses del Valles
 (Barcelona)
 Spain
 +34 938 715 404
 +34 938 605 498 Fax
 iberia@titusplus.com

Titus GmbH, Herford

Lübberlindenweg 12
 DE-32049 Herford
 Germany
 +49 5221 102488-0
 germany@titusplus.com

America

Titus Tool Company Inc.

2800 156th Avenue SE
 Suite 135
 Bellevue, WA 98007
 USA
 +1 800 762 1616 Toll free
 +1 425 746 2080
 +1 425 746 2344 Fax

Titus Tool Co. Inc.

11056 W. Addison Street
 Franklin Park, IL 60131
 USA
 +1 800 762 1616 Toll free
 +1 425 746 2080
 +1 425 746 2344 Fax
 usa@titusplus.com

Australia and New Zealand

Titus Tekform Pty Ltd

83 Jemma Road
 Prestons NSW 2170
 Australia
 +61 2 9286 0007
 +61 2 9826 0074 Fax
 www.titustekform.com.au
 info@titustekform.com.au

Stefano Orlati Ltd

34 Waipareira Avenue
 Henderson
 Auckland
 New Zealand
 +64 9 837 0886
 +64 9 837 8003 Fax
 www.stefano-orlati.co.nz
 stefano-orlati@titusplus.com

Asia

Titus Tool Co. Pte. Ltd.

5004 Ang Mo Kio Ave 5
 Techplace II #04-01
 Singapore 569872
 Singapore
 +65 6383 3922
 +65 6383 3178 Fax
 singapore@titusplus.com

Titus (Shenzhen) Components Co. Ltd.

1st Floor Building No. 2
 Heng Changrong High-tech Industrial
 Park
 ShangNan South Road
 Shangjin Street
 Baoan District Shenzhen Province
 China
 +86 755 8348 0916
 +86 8359 2676 Fax
 china@titusplus.com

Titus Tekform Indonesia, PT

Taman Teknoblok L2 No. 7
 Bumi Serpong Damai Sektor XI
 Indonesia
 +62 21 7587 3578
 +62 21 7587 3574 Fax
 indonesia@titusplus.com

Headquarters

Titus International Ltd
 28 Fitzroy Square
 London
 W1T 6DD
 United Kingdom
 info@titusplus.com

www.titusplus.com
 info@titusplus.com

Titus

info@titusplus.com | www.titusplus.com